



ALUMINIUM SERVICE DOOR FRAMES

Our range of service doors type A, smooth profile are installed without any externally visible screw fixings, they are installed by Sikaflex bonding (see page 101) of the frame to the aperture and the addition of some internal safety screws. They are manufactured from silver anodised Aluminium extrusions for long term visual appearance and strength.

When ordering service doors choose suitable lock or locks from the lock range based on recommended 'NOL' number of locks Shown in size table in price list. We do not supply service doors ready assembled with panel, we only supply frames as shown.



SHOWN WITHOUT LOCK OR PANEL FITTED

THETFORD SERVICE DOORS

The range now covers four sizes. Easy to install, can be fitted either vertically or horizontally, in the outside wall of the body. A step by step installation manual is provided together with a template for cutting the wall and door centre core panel. The section of wall cut out to fit frame is trimmed down and fitted into centre of door. This ensures door centre panel matches any body colour styling. Add colour code to end of code.

Colours available: W= White or CW= Cream/White



All sizes in mm	TLTD3.. DOOR 3	TLTD4.. DOOR 4	TLTD5.. DOOR 5	TLTD6.. DOOR 6
OVERALL SIZE	385x335	685x385	785x335	1038x460
DAYLIGHT OPENING	330X280	630X330	730X280	980X400
LOCK/BUTTON	1	2	2	3
PUSH BUTTON	1	-	-	-

NEW EXTERNAL RELEASE DOOR RETAINER

DC6018K

New positive door retainer designed to fit on the exterior wall of the caravan. Due to its design it positively retains the door and will release with only a light pull on the trigger. A pair of spacers DC6009K are available to fit behind the trigger mechanism. (Colour Black)



DC6018K

NEW TRIGGER RELEASE DOOR RETAINER -

DC6010W

New door retainer designed to fit on the exterior wall of the caravan. it positively retains the door and released with only a light push on the trigger.

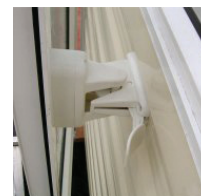

DC6010W

LATCHING DOOR RETAINER

High quality strong latching door retainer. Retainer is fitted through 25mm door panel (screws supplied). Door is pushed onto retainer which is fitted to body side (requires screws) and latches fully. To release door pull on T handle and pull door off retainer.

A pair of spacers one flat one angled is available. Colour: Black.

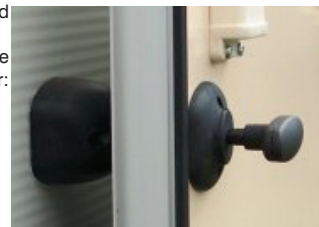

DC6007K LATCHING DOOR RETAINER SET
DC6009K SPACER KIT (1x Flat 1 x Angled)

LOCKABLE ACCESS FLAP

High quality strong lockable access flap, providing access to service points or hidden filler positions. Colour white. Size 160mm high x 215mm long.

ACF03 LOCKABLE ACCESS FLAP

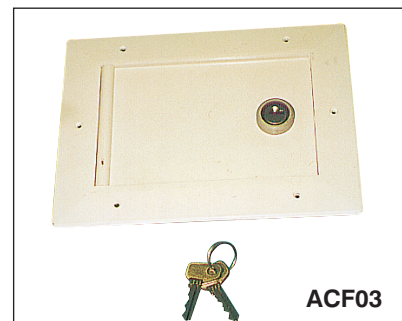
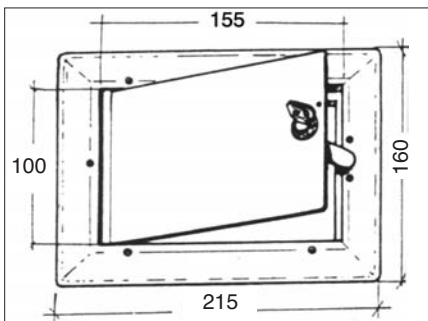
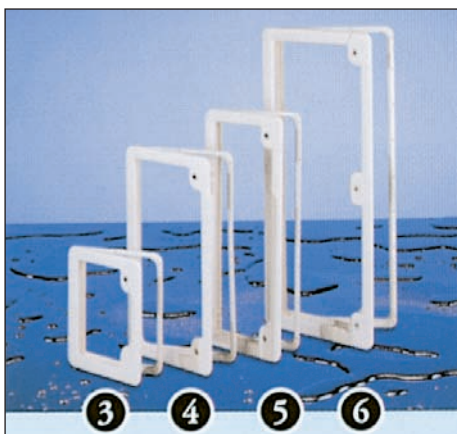

ACF03

THETFORD BATTERY BOX

The Thetford Battery Box is intended to accommodate an auxiliary battery in a caravan or motorhome. The Battery Box has a CE socket to connect the vehicle to a 230 V power source. The Battery Box has the provision of space to be fitted with several sockets and outlets. The approx. side wall aperture is 297mm high x 597mm wide with a depth inwards of 250mm.

Panel thickness: the Battery Box access door can be fitted into panels ranging in thickness from 23 to 40 mm. Standard fit by many OEM's. The door requires a lockset TLZDLK see below to open and lock the door.

TLBBW THETFORD BATTERY BOX & DOOR CR/WHITE REQUIRES LOCKS

THETFORD WET LOCKER

The Thetford Wet Locker Box is a waterproof storage compartment for caravans and motorhomes. The approx. side wall aperture is 297mm high x 597mm wide with a depth inwards of 347mm.

Panel thickness: the wet locker box access door can be fitted with panels ranging in thickness from 23 to 40 mm. Standard fit by many OEM's. The door requires a lockset TLZDLK see below to open and lock the door.

TLWLW THETFORD WET LOCKER & DOOR CR/WHITE REQUIRES LOCKS

LOCK SETS FOR BATTERY BOXES AND WET LOCKERS

A pair of locks and 2 keys as a matching set for installation in the lock housings of the Thetford battery box and Thetford wet locker. The lock barrel is simply pushed home until it clicks to secure it in the housing.

TLZDLK PAIR OF ZADI LOCKS & KEYS FOR BATTERY BOX & WET LOCKER

We can supply any ZADI lock, barrel or keys. Please enquire.

All sizes are approximate. Do not cut hole until measuring the actual product.

We reserve the right to amend product specifications without prior notice. E & O E.

WE NOW OFFER INSTALLATION SERVICE



TLBBW BATTERY BOX



TLWLW WET LOCKER

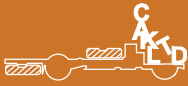

NEW LOCKS & HEOSAFE CABLOCKS



Doors & Locks

SINGLE KEY SYSTEM WITH NEW LOCK

For ease of use and to prevent a huge bunch of keys our new lock system allows certain products to have the lock barrel installed afterwards. This enables a set of matching locks to be purchased and installed in a range of filler caps and service door locks. All will therefore be able to be opened with the same key. Items marked requires lock detailed below and in other parts of the catalogue (Easy Fill on page 19) allow the installation of matching key number lock cylinders. Where products are marked with lock & two keys these key numbers are random and cannot be supplied matching.

LOCKS FOR SERVICE DOORS

To suit various styles and installation needs, the most popular service door lock is the **LDL1036**, due to its neat and simple operation and reliability in use. On unlocking **LDL1036** the knob pops out, rotate this to move pawl on rear to unlock & lock, then line up knob with base and push in until it clicks to lock. **LDL1035, 1047, 1105 & 1109** use turning of the key to rotate lock pawl on rear.

- LDL1035N** 1035 BARREL LOCK 32MM CHROME BODY REQUIRES LOCK (A)
- LDL1041CVK** BLACK COVER CAP & LOOP FOR 1035 & 1047 LOCKS (B)
- LDL1036RL** 1036 BLACK DOOR LOCK REQUIRES LOCK
- LDL1036L** 1036 BLACK DOOR LOCK WITH LOCK & 2 KEYS. (C)
- LDL1047** 1047 BARREL LOCK 38MM CHROME BODY REQUIRES LOCK (D)
- LDL1105W** MOON WHITE DOOR HANDLE LOCK LEFT REQUIRES LOCK (F)
- LDL1109W** MOON WHITE DOOR HANDLE LOCK RIGHT REQUIRES LOCK (G)
- LDLNK1** NEW LOCK 1 X LOCK & PAIR OF KEYS RANDOM NUMBERS (H)
- LDLWALK2** WEST ALLOY LOCK BARREL WITH 2 KEYS

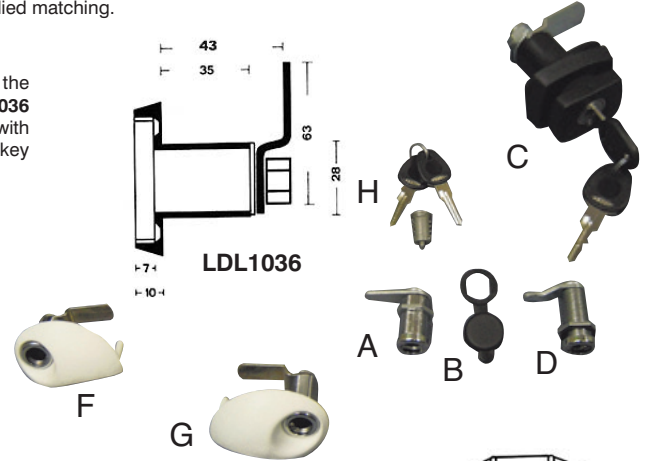

NEW MATCHING LOCK KITS

With the new lock kits order as many sets of locks at the same time as you need to complete the job. We will pick a 4 digit key number and this will show on your invoice instead of the stars. When you need to order extra matching locks in the future quote this key number in place of the 4 stars at the end of the lock set code.

- LDLNK4****** NEW LOCK KIT 4 X LOCK & 2 X KEYS TO KEY NUMBER
- LDL1042NKB** KEY BLANK FOR NEW LOCK SYSTEM



PLASTIC OPEN DOOR RETAINER CATCH

Door retainer catches for service and entrance doors. Male fixture has angled face to allow for hinging gap angle. Standard fit by almost all OEM's. Colours available G= Grey, K= Black & W= White, Add this letter to end of code.

- DC1004** HIGH STRENGTH DOOR RETAINER CATCH (1 SET)
- DC1019** 10 MM SPACER BLOCK FOR DC1004



DC1088
10mm SPACER BLOCK FOR DC1087



DC1087
DOOR CATCH

BALL TYPE DOOR RETAINER CATCH

New larger variation on above door retainer, Ball design makes for easier lining up and positioning in any direction.

- DC1087** BALL TYPE DOOR RETAINER CATCH (1 SET)
- DC1088** 10MM SPACER BLOCK FOR DC1087

HEOSAFE SECURITY CAB DOOR LOCKS

Many Motorhome and Caravan owners do not feel that the standard vertical locks are adequate protection against illegal entry. Many owners attempt to overcome the feeling by installing a range of various options from drilling and bolting in 'eyebolts, straps and chain' to Cutting holes and fitting 'dead locks/bolts'. The HEOSafe however, has been designed by Oskar Kubesch to increase the safety of the vehicle and it's occupants against illegal entry whilst also removing the need for drilling and cutting holes into doors. The lock is mounted by using the existing fixings of the manufacturer and is very simple and easy to use.

The characteristics of the HEOSafe door lock are: Maintenance free; Quick and Easy to fit and use; No additional drilling or screwing required (excl. x250, Movano & Ford Transit door lock additional drilling and screwing required) & 3 year guarantee Standard Kit weight 2.00kg (delivered as a pair, left door and right door)

- HSL1246** Heosafe Fiat Ducato 230 Boxer Relay (1994-2002) standard
- HSL1256** Heosafe Fiat Ducato 230 Boxer Relay (1994-2002) lockable
- HSL12146** Heosafe Fiat Ducato 244 Boxer Relay (2002-2005) standard
- HSL12156** Heosafe Fiat Ducato 244 Boxer Relay (2002-2005) lockable
- HSL12546** Heosafe Fiat Ducato 250 Boxer Relay (2006- on) standard
- HSL12556** Heosafe Fiat Ducato 250 Boxer Relay (2006- on) lockable
- HSL1356** Heosafe Mercedes Sprinter lockable (-2006)
- HSL1456** Heosafe Ford Transit lockable (2000 -2006)
- HSL14156** Heosafe Ford Transit (2006- on) lockable
- HSL1556** Heosafe Renault Master, Vaux Movano & Iveco Daily lockable

NEW ZADI DOOR LOCKS

We have available the full range of ZADI replacement barrels and keys for Access and Entrance door locks as well as a selection of access door locks. We also have barrels and keys for West Alloy WD short barrel locks.



HSL1356

HSL1456, HSL12556 & HSL1556

HSL12546

HSL1256 LOCKING HSL1246 NON LOCK

HSL12156

HSL12146



0844 414 2324



0844 414 2425